



ACP Sentry Median Barrier

Longitudinal Median Barrier

Product and Installation Manual

Please call Australian Construction Products on 1800 724 172 or visit www.acprod.com.au for more information

May 2019

v1.6

SMARTER SAFETY SOLUTIONS



ACP

AUSTRALIAN CONSTRUCTION PRODUCTS

Product and Installation Manual: ACP Sentry Median Barrier

Contents

Introduction	4
System Overview.....	5
Limitations and Warnings	6
Training	6
Health and Safety.....	6
Before Installation.....	7
Safety statements	7
General Safety.....	7
ACP Sentry Median Barrier Safety Statements	7
Limited Warranty	7
System Design and Design Considerations	9
Product Orientation	9
Kerbs	9
Horizontal and Vertical Curves.....	9
Slopes.....	10
Undulating Ground Conditions	10
Clear Zone / Hazard Free Zone	10
Terminal Ends	10
Soil Condition	11
Length of Need	11
System Deflection.....	12
Transitions	12
Parts Identification	13
Bill of Materials.....	14
Installation Procedure	14
Getting Started	14
Preparation	14
Soil Conditions.....	15
Tools Required.....	15
Installation Tolerances	17
ACP Sentry Median Barrier–Installation Instructions	18
Site Preparation.....	18
Post driver machine - Impact head.....	18
Construction of Terminal End	19

Product and Installation Manual: ACP Sentry Median Barrier

Installation Procedure (Posts and W-beam)	19
Installation Checklist	23
Inspection and Maintenance	23
Requirement after a Bushfire or Flooding.....	23
Frequently Asked Questions.....	24
Appendices	25
Appendix A – ACP SENTRY MEDIAN BARRIER	25
Appendix B – ACP SENTRY MEDIAN POST	26
Appendix C – ACP SENTRY WASHER.....	27
Appendix D – ACPF1640 (M16X50 Bolt and Nut)	28
Appendix E – SENTRY TOLERANCE	29
Appendix F – SENTRY MEDIAN BARRIER TRANSITION TO X350M MEDIAN TERMINAL..	30
Appendix G – ACP SENTRY MEDIAN BARRIER INSTALLATION CHECKLIST.....	31
Appendix H – ACP SENTRY MEDIAN BARRIER INSPECTION CHECKLIST	32
Appendix I – ACCEPTABLE POST DEFORMATION MEASURES & TOLERANCES	35
Test 1: Nut Pass-through.....	35
Test 2: Washer Fitment	35
Test 3: Post deformation bending and cracking tolerance.....	36

Product and Installation Manual: ACP Sentry Median Barrier

Introduction

The **ACP Sentry Median Barrier** is a w-beam guardrail system suitable for containing, redirecting and shielding vehicles from opposing traffic or dual carriageways. The barrier has been designed and tested to meet the evaluation criteria of MASH Test Level 3 for a longitudinal median barrier configuration. MASH TL3 is the latest testing standard and it has significantly higher impact conditions than the out-dated NCHRP 350 standard.

The **ACP Sentry Median Barrier** has an initial installation height of 790 mm (31”) to the top of the guardrail, providing the system with the ability to withstand numerous road surface overlays without the need to relevel or lifting of the barrier. The **ACP Sentry Median Barrier** must be installed with the approved **X-350 Median** terminal end on the approach and departure ends.

The rounded edges to the **ACP Sentry Barrier Post** and closed shape on the approach direction provide increased protection for vulnerable road users. The compact **ACP Sentry Barrier Posts** are easy to drive into all soil types and provide increased resistance to rotation in the soil when impacted. Unlike other systems on the market, any damage caused to the top of the posts or to the rail mounting points during installation will not affect the performance of the system.

The connection system between the rail and posts is formed using conventional fasteners providing it with the greatest tolerance of any system on the market. If the connection is damaged in any way it can be easily replaced without replacing the posts allowing for simpler installations and repairs. The **ACP Sentry Median Barrier** is installed quickly using conventional installation tools and equipment. It does not require the use of blockouts, making it one of the narrowest systems on the market.

Product and Installation Manual: ACP Sentry Median Barrier

System Overview

The **ACP Sentry Median Barrier** is designed to provide acceptable structural adequacy, minimal occupant risk and safe vehicle trajectory as required by the latest in safety standards, AASHTO MASH Test Level 3 (TL3). This system was independently evaluated under full impact conditions of 100 km/hr and impact angles of 25 degrees.

When impacted by an errant vehicle, the **ACP Sentry Median Barrier** will redirect the vehicle along the face of the barrier system, bringing it to a controlled stop. The system has been developed to produce minimal debris during an impact, with all posts designed to remain firmly located in the soil and the connection details to remain attached to the rail. Repair of the system is completed by removing and replacing any bent or damaged w-beam and posts impacted accordingly. Any posts with damaged connections can be repaired by replacing the connection hardware only, reducing the need to remove posts and repair damaged ground.

Key specifications for the **ACP Sentry Median Barrier** are:

System width	283 mm
Height to top of rail	800 mm
Height to top of post	790 mm
Post weight	13.6 kg
Post length	1.64 m
Post spacing	2.00 m
Dynamic deflection (1,175 kg vehicle)	1.10 m
Dynamic deflection (2,270 kg vehicle)	1.59 m

The minimum Length of Need (LoN) of the **ACP Sentry Median Barrier** is dependent on the posted speed limit. Please refer to state roading authority approval letters for local minimum length requirements. However, a minimum length of need for a two-way road with a posted speed limit of 100 km/hr with a clear zone of approaching traffic is recommend as 30 m, excluding terminal ends.

The **ACP Sentry Median Barrier** systems rails and posts are manufactured from hot-rolled steel flat products in accordance with Standard AS/NZS 1594 and hot-dip galvanised in accordance with Standard AS/NZS 4680 with an average minimum coating thickness of 35 microns. All galvanising is undertaken after fabrication is completed to ensure no surfaces are left untreated.

The **ACP Sentry Median Barrier** has been designed for strength and resilience.

Product and Installation Manual: ACP Sentry Median Barrier

Limitations and Warnings

The **ACP Sentry Median Barrier** forms part of an approved roadside protection system and it must be installed in conjunction with an approved terminal end system on both the approach and trailing ends. When installed in accordance with the manufacturer's instruction the barrier system allows an impacting vehicle to be re-directed in a safe and predictable manner under the MASH impact conditions.

Vehicle impacts that vary from the MASH impact conditions for longitudinal barriers may result in significantly different outcomes from those obtained in the experimental testing and may not meet the MASH evaluation criteria.

The selection and placement of the **ACP Sentry Median Barrier** must be in accordance with the Roading Controlling Authorities guidelines and the details shown in the construction drawings. Installation must be within strict accordance with the installation instructions for the product. Alternative installation techniques will be required if the soil conditions on site do not meet the minimum requirements stated in this manual.

Training

All Installers must undergo formal training on the installation of the **ACP Sentry Median Barrier** by an approved trainer. At the completion of the training, installers will be able to identify each component of the **ACP Sentry Median Barrier**, knowledge of the correct methods to handle the equipment and have the knowledge to safely install the barrier as per the Installation Manual and Specifications required.

The training will also include the correct Personal Protective Equipment (PPE) required to be worn during installation and maintenance.

Health and Safety

Installers should comply with all necessary health and safety legislation in the local jurisdiction, including all safe work and lifting practices.

All appropriate traffic safety precautions must be adopted. All workers must wear the required safety clothing, including but not limited to, high visibility vests, steel capped footwear, gloves and protective glasses etc.

Before undertaking any earth works, including drilling or driving of posts, always check with the appropriate service providers that the area is clear of underground services

All installers must be well clear of machinery when posts are being driven.

Product and Installation Manual: ACP Sentry Median Barrier

Before Installation

Design and placement of the **ACP Sentry Median Barrier** shall be in accordance with the local Road Controlling Authority's guidelines and as per the details shown in the construction drawings. Installation shall be in accordance with the Product and Installation Manual instructions supplied for this product.

The **ACP Sentry Median Barrier** is an engineered safety device. Before starting installation ensure familiarity with all components of the system.

Note: Soil conditions may require a local geotechnical engineer to confirm the soil condition on site met the required condition described in the manual.

Safety statements

General Safety

- All required traffic safety precautions should be complied with. All workers should wear required safety clothing (examples, but not limited to, include: high visibility vests, steel capped footwear, gloves etc).
- Only authorised trained personnel should operate any machinery. Where overhead machinery is used, care must be taken to avoid any overhead hazards.
- Before drilling or excavation always ensure that the area is clear of underground services. The appropriate service providers may need to be contacted.

ACP Sentry Median Barrier Safety Statements

- All installers must be a safe distance from all drilling or excavating machinery operating.
- The components are not heavy enough to require specialised lifting equipment, but due to the dimensions and bulky nature, care should be taken when lifting the larger components into position.
- Avoid placing hands or fingers in and around moving machine parts when components are being lifted and manoeuvred into place.

Limited Warranty

Australian Construction Products (ACP) has tested the impact performance of its barriers and crash cushion systems, and other highway safety hardware under controlled conditions, however, ACP does not represent nor warrant that the results of those controlled conditions would necessarily avoid injury to persons or property.

Product and Installation Manual: ACP Sentry Median Barrier

ACP EXPRESSLY DISCLAIMS ANY WARRANTY OR LIABILITY FOR CLAIMS ARISING BY REASONS OF DEATH OR PERSONAL INJURY OR DAMAGE TO PROPERTY RESULTING FROM ANY IMPACT, COLLISION OR HARMFUL CONTACT WITH THE PRODUCTS OR NEARBY HAZARDS OR OBJECTS BY ANY VEHICLE, OBJECTS OR PERSONS.

ACP warrants that any product or component part manufactured by ACP will be free from defects in material or workmanship. ACP will replace free of cost any Product or component part manufactured by ACP that contains such a defect.

THE FOREGOING WARRANTY IS IN LIEU OF AND EXCLUDES ALL OTHER WARRANTIES NOT EXPRESSLY SET FORTH HEREIN, WHETHER EXPRESS OR IMPLIED BY OPERATION OF LAW OR OTHERWISE, INCLUDING BUT NOT LIMITED TO ANY IMPLIED WARRANTIES OF MERCHANTABILITY OR FITNESS FOR A PARTICULAR PURPOSE. ACP'S LIABILITY UNDER THIS WARRANTY IS EXPRESSLY LIMITED TO REPLACEMENT FREE OF COST OF PARTS SUPPLIED BY ACP ONLY (IN THE FORM AND UNDER THE TERMS ORIGINALLY SHIPPED), OR TO REPAIR OR TO MANUFACTURE BY ACP, PRODUCTS OR PARTS NOT COMPLYING WITH ACP SPECIFICATIONS, OR, AT ACP'S ELECTION, TO THE REPAYMENT OF AN AMOUNT EQUAL TO THE PURCHASE PRICE OF SUCH PRODUCTS OR PARTS, WHETHER SUCH CLAIMS ARE FOR BREACH OF WARRANTY OR NEGLIGENCE. ACP SHALL NOT BE LIABLE FOR ANY INCIDENTAL, CONSEQUENTIAL OR SPECIAL LOSSES, DAMAGES OR EXPENSES OF ANY KIND, INCLUDING, WITHOUT LIMITATION, ANY SUCH LOSSES, DAMAGES OR EXPENSES ARISING DIRECTLY OR INDIRECTLY FROM THE SALE, HANDLING OR USE OF THE PRODUCTS FROM ANY OTHER CAUSE RELATING THERETO, OR FROM PERSONAL INJURY OR LOSS OF PROFIT.

Any claim by the Buyer with reference to Products sold hereunder for any cause shall be deemed waived by the Buyer unless ACP is notified in writing, in the case of defects apparent on visual inspection, within ninety (90) days from the delivery date, or, in the case of defects not apparent on visual inspection, within twelve (12) months from the said delivery date. Products claimed to be defective may be returned prepaid to ACP's plant for inspection in accordance with return shipping instructions that ACP shall furnish to the Buyer forthwith upon receipt of the Buyer's notice of claim. If the claim is established, ACP will reimburse that Buyer for all carriage costs incurred hereunder.

The forgoing warranty benefits shall not apply to (i) any Products that have been subject to improper storage, accident, misuse or unauthorised alterations, or that have not been installed, operated and maintained in accordance with approved procedures and (ii) any components manufactured by the Buyer.

Product and Installation Manual: ACP Sentry Median Barrier

System Design and Design Considerations

Product Orientation

The **ACP Sentry Median Barrier** can be installed between lanes or roads travelling in a single or opposing direction. The installation will remain the same with the exception of the overlapping of the W-beam (“guardrail”) as stated by Standard AS/NZS 3845.1:2015.

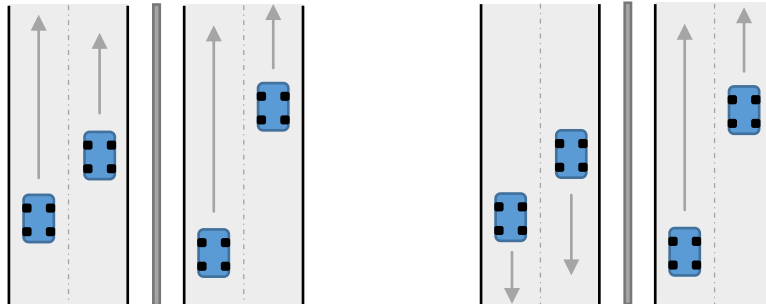

Single traffic direction

Opposing traffic direction

Kerbs

As with all road side safety hardware, the **ACP Sentry Median Barrier** has been designed and tested so that the centre of gravity of the impacting vehicle is at a constant height in relation to the system. For this reason, it is preferred that kerbs or channels are not in front or directly behind the **ACP Sentry Median Barrier** as they may result in altering the height of the vehicle at impact.

If interaction with a kerb cannot be avoided consult the local Road Controlling Authority guidelines regarding allowable kerb heights, kerb shapes, and barrier offset distance.

Horizontal and Vertical Curves

The **ACP Sentry Median Barrier** can accommodate both horizontally and vertically curved guardrail panels if required by site conditions. For radii less than 25m the system must be anchored with an approved intermediate anchor or terminal end. Please refer to approved details of the local Road Controlling Authority where necessary.

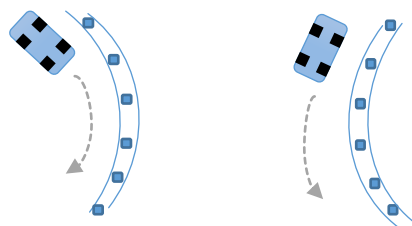

Concave Corner

Convex Corner

Product and Installation Manual: ACP Sentry Median Barrier

Slopes

The **ACP Sentry Median Barrier** can be installed on ground with a maximum cross fall of 6H:1V. For steeper slopes it is recommended that the system is installed no closer than 300 mm to the batter hinge point of the slope. If an installation with clearance less than 300 mm is required, please contact your local ACP Distributor.

Note: Installations in close proximity to a batter hinge must be considered within the requirements of the road controlling authority.

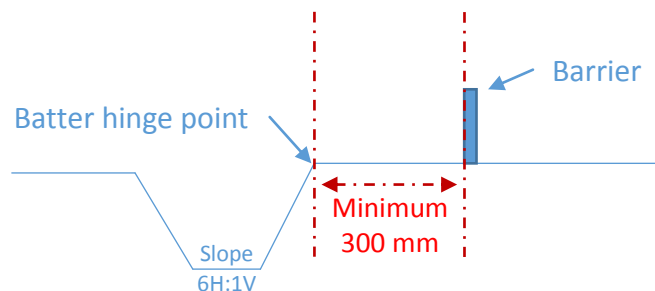

Undulating Ground Conditions

Site specific grading may be necessary to ensure that there are no 'humps' or 'hollows' that may significantly alter the impacting vehicles stability or substantially alter the W-beam heights in relation to the ground. The **ACP Sentry Median Barrier** is required to be installed level and centred on the barrier line as stated in the Installation Procedure.

Care must be taken to ensure all posts in the **ACP Sentry Median Barrier** are installed to the correct height, alignment and orientation. It is strongly recommended that smoothing of uneven ground conditions be completed along the length of the **ACP Sentry Median Barrier**.

Clear Zone / Hazard Free Zone

Clear Zones are areas adjacent to traffic lanes that provide errant vehicles the opportunity to slow down or recover. The clear zone must be kept clear from roadside features that could be hazardous to an errant vehicles, such as but not limited to trees, poles and culverts. Although it is desirable to maximize the available clear zone, please refer to your local Road Controlling Authority for confirmation of the minimum width requirements.

Terminal Ends

The **ACP Sentry Median Barrier** is designed to be compatible with the **X-350 Median** terminal end. Refer to *Appendix F – Sentry Median Barrier Transition to X350M Median Terminal* in this manual for guidance on installation.

Product and Installation Manual: ACP Sentry Median Barrier

The purpose of the w-beam guardrail terminal ends or crash cushions is to provide a soft impact and to prevent the end rail from spearing or impacting the errant vehicle. The terminal ends and crash cushions also provide tensile and deflection strength necessary to ensure the errant vehicle is redirected for the length-of-need required.

- Care must be taken to ensure the correct post spacing.
- Care must be taken to ensure the posts are orientated correctly and ensure all bolts are inserted and tightened accordingly.
- Care must be taken to ensure the line posts are installed at the correct height.

Soil Condition

The **ACP Sentry Median Barrier** is a soil-mounted system driven directly into the soil. To meet the barrier's performance requires the soil to meet AASHTO Grade B standard and requirements set out by Standard AS/NZS 3845.1:2015 and TNZ Specification M/4 2006.

Soil conditions on site not meeting these requirements will require alternative installation. Contact your ACP Distributor for details. It is strongly recommended that soil tests be completed at the location where the **ACP Sentry Median Barrier** is to be installed.

Note: All technical information required to assist in designing a site specific foundation is available from ACP Distributor.

IF SOIL CONDITIONS ON SITE DO NOT MEET OR EXCEED THE REQUIRED STRENGTH, SITE SPECIFIC CONDITIONS, REFER TO A LOCAL GEOTECHNICAL ENGINEER FOR FURTHER ADVICE.

Length of Need

The minimum Length of Need (LoN) of the **ACP Sentry Median Barrier** is dependent on the specific hazard being protected and the posted speed limit. Please refer to state Roading Control Authority approval letters for local minimum length requirements.

The minimum LoN for a two-way road with a posted speed limit of 100 km/hr with a clear zone of approaching traffic is recommended as 30 metres plus the length of the terminal end on either end of the barrier system. We recommend Installers contact their local Roading Control Authority for further information or guidance.

Note: As per the LoN design section of the Roading Control Authorities guidelines, care must be taken when calculating the actual length of a barrier required versus the theoretical length of need.

Product and Installation Manual: ACP Sentry Median Barrier

System Deflection

The transverse deflection of a barrier during a crash is dependent upon the mass, speed, and impact angle of the errant vehicle. The dynamic deflection of the **ACP Sentry Median Barrier** is derived from physical testing completed on the ACP Sentry Barrier System in both roadside configuration (single sided) and median configuration (double sided).

The maximum measured dynamic deflection (2270 kg vehicle) of the system was recorded as 1.59 m.

A review of the proposed barrier location can be undertaken to assess the following variables influence on the likely maximum system deflection;

- Maximum attainable impact angle;
- Design speed; and
- Vehicle size and mass.

Please refer to your ACP Distributor for assistance on determining site specific deflections based on these parameters.

Transitions

A transition zone may be required to connect the **ACP Sentry Median Barrier** to other types of barriers or non-approved terminal ends. Please contact your ACP Distributor for guidance on acceptable transition systems, advice may differ across different state roading jurisdictions.

Refer to Appendix F – Sentry Median Barrier Transition to X350M Median Terminal in this manual for guidance on installation.

Product and Installation Manual: ACP Sentry Median Barrier

Parts Identification



ACP Sentry Median Barrier Post (2 views)



ACP Sentry Barrier Bolt, Washer and Nut



Splice Bolt and Nut



W-beam

ALL STEEL COMPONENTS USED IN THE ACP SENTRY MEDIAN BARRIER ARE HOT DIPPED GALVANISED IN ACCORDANCE WITH STANDARD AS/NZS 4680:2006 (AVERAGE MINIMUM COASTING THICKNESS SHOULD BE 35 MICRONS) WITH THE EXCEPTION OF THE ACP SENTRY BARRIER WASHER BEING SPUN GALVANISED.

Product and Installation Manual: ACP Sentry Median Barrier

Bill of Materials

Bill of Materials – Checklist per panel (4 m of barrier) installed	Yes
<ul style="list-style-type: none"> ➤ 2 x ACP Sentry Median Barrier Posts (per W-beam) ➤ 2 x ACP Sentry Barrier Bolt, Washer and Nut (two per post) ➤ 2 x W-beam ➤ 16 x Splice Bolts and Nuts (at the end of W-beam and overlapping the prior W-beam) 	
<p>General equipment required</p> <ul style="list-style-type: none"> ➤ Drilling or compactor suitable for foundation ➤ String line and pegs ➤ Measuring tape ➤ Level ➤ 32mm Wrench ➤ 32mm Ring Spanner ➤ Automatic drill (with 10mm allen key hex bit) 	

Installation Procedure

Getting Started

The **ACP Sentry Median Barrier** is a w-beam barrier designed to run the length of need required and is attached to a compatible terminal end. The minimum Length of Need (LoN) allowed is dependent on the post speed limit. For a 100 km/hr zone a minimum LoN of 30 metres is recommended, excluding the proposed terminal end.

Preparation

Before installing an **ACP Sentry Median Barrier**, ensure that all components required for the system are on site and have been identified. The **ACP Sentry Median Barrier** is an engineered safety device. Before starting installation ensure familiarity with the makeup of the system. Refer to the Bill of Materials and Parts Identification sections in this manual for more information.

Ensure that the area where the **ACP Sentry Median Barrier** is to be installed is sufficiently flat so that the posts and w-beam can be installed within the allowable tolerance and aligned to the terminal ends. Minor site grading may be required.

Product and Installation Manual: ACP Sentry Median Barrier

Soil Conditions

The **ACP Sentry Median Barrier** has been designed to withstand a constant static load, thermal loading, and dynamic impact load that can be applied from the impact of an errant vehicle. To perform, the **ACP Sentry Median Barrier** must be attached to an **X-350 Median** terminal end to provide the necessary safety benefits. It is recommended that the soil tests are carried out at the location the **ACP Sentry Median Barrier** prior to being installed.

IF SOIL CONDITIONS ON SITE DO NOT MEET OR EXCEED THE REQUIRED STRENGTH DETAILED IN THIS MANUAL, SITE SPECIFIC FOUNDATIONS MUST BE DESIGNED BY A LOCAL GEOTECHNICAL ENGINEER

Tools Required

The tools required to install the **ACP Sentry Median Barrier** are similar to other W-beam barriers. It requires:

- Appropriate personal protective equipment
- Drilling or compactor machinery (suitable for soil conditions and with a driving head to avoid damage to posts during installation)



- String line



Product and Installation Manual: ACP Sentry Median Barrier

- Measuring tape



- Level



- 32mm Socket wrench or ratchet



- 32mm Ring spanner



- Automatic drill (with 10 mm allen key hex bit)



Product and Installation Manual: ACP Sentry Median Barrier

Installation Tolerances

The **ACP Sentry Median Barrier** is an engineered safety device. To obtain optimal performance it is important to install all components of the system to within the allowable tolerances stated below (also in *Appendix E*). Particular care must be taken to ensure;

- Suitable horizontal alignment and verticality of the line posts.
- Consistency in the vertical height of the line posts.
- Orientation and height of the terminal end.

ACP Sentry Median Barrier has to be installed at 780mm to the top of the post. A vertical height tolerance of +25mm is acceptable for the **ACP Sentry Barrier Post**. The top of the W-beam is to be positioned 10mm above the top of the **ACP Sentry Barrier Post** with an additional tolerance of ± 5 mm. The **ACP Sentry Barrier Post** laterally is constrained to ± 15 mm tolerance. It is of utmost importance for these tolerances to be adhered to in order to ensure safe function of the **ACP Sentry Median Barrier**.

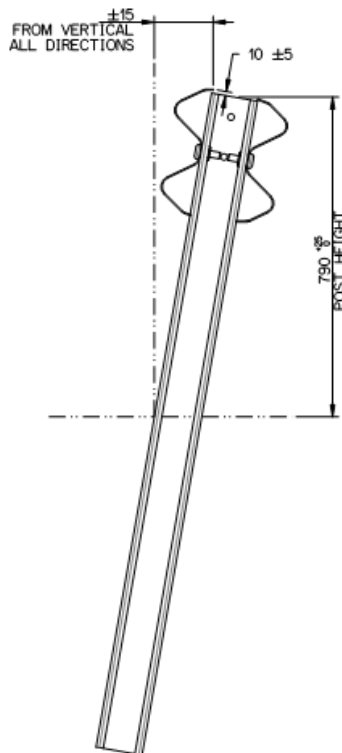

Once installed, the relative height of the **ACP Sentry Median Barrier** to the surrounding road surface may alter due to road surface overlays. Experience has shown that the overlays may be acceptable until the relative height from the top of the rail to the road surface falls below 715 mm. Please contact your ACP Distributor should the installation fall outside this tolerance.

Product and Installation Manual: ACP Sentry Median Barrier

ACP Sentry Median Barrier – Installation Instructions

Before installing the **ACP Sentry Median Barrier**, ensure that all components required for the system are on site and have been identified. The **ACP Sentry Median Barrier** is an engineered safety device made up of relatively small number of parts. Please ensure familiarity with the makeup of the system and the installation process prior to commencing. If required, refer to the **Bill of Materials** and **Parts Identification** sections in this manual for more information.

Site Preparation

It is preferred that the **ACP Sentry Median Barrier** be installed on flat, level ground and connected to an approved terminal end. The positioning of the **ACP Sentry Median Barrier** commences from the last post connected to the terminal end, working upstream to the prior terminal end. It is recommended that a string line be used to obtain the correct orientation and placement of the posts and are aligned to the terminal end.

BEFORE DRILLING OR EXCAVATION ALWAYS ENSURE THAT THE AREA IS CLEAR OF UNDERGROUND SERVICES

Post driver machine - Impact head

Ensure a suitable post driver impact head that has been designed to drive Sentry posts is used in order to avoid damage to posts during installation. Below are examples of suitably designed impact heads. Contact ACP for assistance if required.



In cases where very hard ground conditions are encountered, minor deformation may occur near the top of the post. If it occurs, please refer to *Appendix I – ACCEPTABLE POST DEFORMATION MEASURES & TOLERANCES*, to determine if the deformation is acceptable for the continuation of installation.

Product and Installation Manual: ACP Sentry Median Barrier

Construction of Terminal End

The **ACP Sentry Median Barrier** is compatible with the **X-350 Median** terminal end which provides optimal performance. Please refer to the relevant **X-350 Median** terminal end installation Manual for guidance to the construction and installation procedure.

Also refer to Appendix F – Sentry Median Barrier Transition to X350M Median Terminal in this manual for guidance on installation.

Installation Procedure (Posts and W-beam)

Step 1

Review the site location and identify possible hazards prior to commencing the installation of the **ACP Sentry Median Barrier**. Any concerns, please refer to the local Roading Authority.



Step 2

a) Place a string line from the centre of the downstream terminal end to required location of the upstream terminal end.



b) The string line should pass over the centre of each post location and be marked accordingly as the required location for drilling or driving each post.



Step 3

a) Identify the correct orientation of the post.



Product and Installation Manual: ACP Sentry Median Barrier

- b) The post must be vertically aligned and within the tolerance level stated in the Installation tolerance drawings. The driving of the post should not incur any damage to the post. If a post is damaged it must be inspected and removed if deemed appropriate.



- c) Drive the posts to a depth of 850mm (790 mm protruding above ground) as stipulated in the drawings.



Step 4

- a) Supporting the w-beam in the desire location.



- b) It is vital that each w-beam must overlap the prior w-beam positioned downstream as stated in Standard AS/NZS 3845.1:2015. Failure to correctly overlap the w-beam may cause snagging, poor barrier performance or risk injury or death to the driver of the errant vehicle.

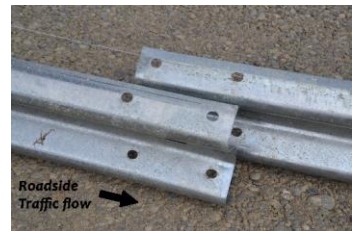

- c) Install the Sentry Median Barrier Bolt, Washer and Nut to the Sentry post.



Product and Installation Manual: ACP Sentry Median Barrier

Step 5

- a) Once supported by the Sentry Median Barrier Bolt, insert the 8 Splice Bolts and Nuts joining the upstream and downstream together. Snug tighten all bolts once installed.

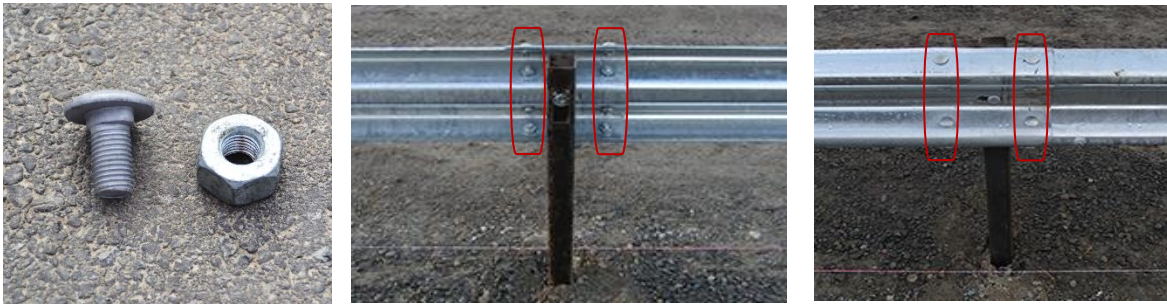

Step 6

Repeat Step 4 and Step 5 on the opposing side of the barrier. Continue working downstream from the first installed w-beam, connected to the terminal end. Once the first row of w-beam has been installed, continue on the reverse side until all w-beams have been attached.



CAUTION:

Please ensure the correct overlapping of the w-beam in accordance to the direction of the traffic flow and as stated by Standard AS/NZS 3845.1:2015.

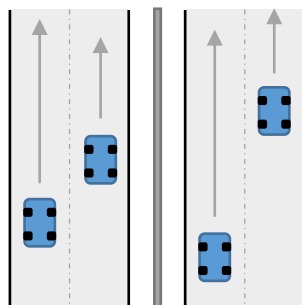

Single traffic direction

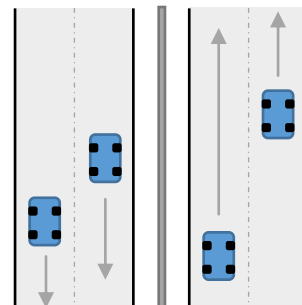

Opposing traffic direction

Product and Installation Manual: ACP Sentry Median Barrier

Step 7

- a) Once the barrier is installed, a detailed visual inspection should be completed to ensure all components are installed as stated in the Product and Installation Manual.



Any questions or concerns regarding the **ACP Sentry Median Barrier**, please contact your local ACP Distributor.

Product and Installation Manual: ACP Sentry Median Barrier

Installation Checklist

Periodically, and at the completion of the installation, an inspection by a qualified inspector is required to ensure the **ACP Sentry Median Barrier** has been installed as stated in the Installation Manual. Failure to complete the Installation checklist (See *Appendix G – ACP SENTRY MEDIAN BARRIER INSTALLATION CHECKLIST*) may render the installation as being incomplete. Any item identified as notifiable, must be highlighted to the local roading authority immediately.

Inspection and Maintenance

The **ACP Sentry Median Barrier** is maintenance free. To allow the Sentry Median Barrier to perform as designed, regular inspections and maintenance (where required) should be conducted. These inspections should follow the Road Safety Barrier Systems and Devices Standard (AS/NZS 3845.1:2015) maintenance suggestions of:

- System documentation
- Operating environment
- Traffic volumes and composition
- Risks at the site

Local Roding Authorities may follow their own inspection process. Please contact your local Roding Authority, in the first instance, to confirm the correct processes or documentation required. This may include a specific response time for repairs, require spare parts to be carried by the inspector or the visual inspection by a qualified inspector.

In the case of no local roading authority process or documentation, please refer to the *Appendix H - ACP Sentry Median Barrier Inspection Checklist* included within this installation manual.

Requirement after a Bushfire or Flooding

Following a bushfire or flooding, an inspection of the **ACP Sentry Median Barrier** should be undertaken. This inspection will follow the standard inspection and maintenance process as documented in *Appendix H - ACP Sentry Median Barrier Inspection Checklist*. Special attention should be applied to the galvanising of the components when impacted by a bushfire and special attention to the soil conditions after flooding.

Any concerns, please refer to the **ACP Sentry Median Barrier** Product Manual or contact ACP for recommendations or inspections of the **ACP Sentry Median Barrier** itself.

Product and Installation Manual: ACP Sentry Median Barrier

Frequently Asked Questions

1. What type of equipment is required to install the ACP Sentry Median Barrier?

Standard tools required include a wrench, automatic drill, measuring tape, string line and machinery suitable for drilling or compacting the post into soil.

2. Does your company provide spare parts? What is the lead-time for supply?

It is important to fix a damaged W-beam barrier as soon as possible because it most probably won't perform as designed when damaged. For this reason it is recommended that spares are held by Maintenance Contractors. The lead time for parts will generally be next day delivery or collection from one of our distribution centres.

3. On average, how long does it take to install the ACP Sentry Median Barrier?

Depending on circumstances at the site, installation and assembly of the system should take a three person crew less than 20 mins per W-beam panel (4.0 m length) when using automatic post driving equipment. Installation time will vary depending on ground conditions when hand digging and re-compacting posts.

4. What about vandalism, can the ACP Sentry Median Barrier be damaged easily?

No, once the system has been fully installed it becomes a rigid system unlikely to be damaged or weaken the performance of the system.

5. How easily can the ACP Sentry Median Barrier be restored after impact?

ACP Sentry Median Barrier is easily repaired following an impact. Damaged posts can be removed using a crow bar and new posts installed before replacement w-beam and splice bolts are positioned.

The connection detail used between the post and the rail of the ACP Sentry Median Barrier is designed to limit damage to the post outside of the immediate zone of impact. When the connection is damaged, the washer detail can be easily replaced without needing to replace the post.

6. What maintenance does the ACP Sentry Median Barrier require?

The ACP Sentry Median Barrier is maintenance free. However it is recommended that all w-beam barrier systems are checked after impacts to ensure that the integrity of the barrier is maintained.

Product and Installation Manual: ACP Sentry Median Barrier

Appendices

Appendix A – ACP SENTRY MEDIAN BARRIER

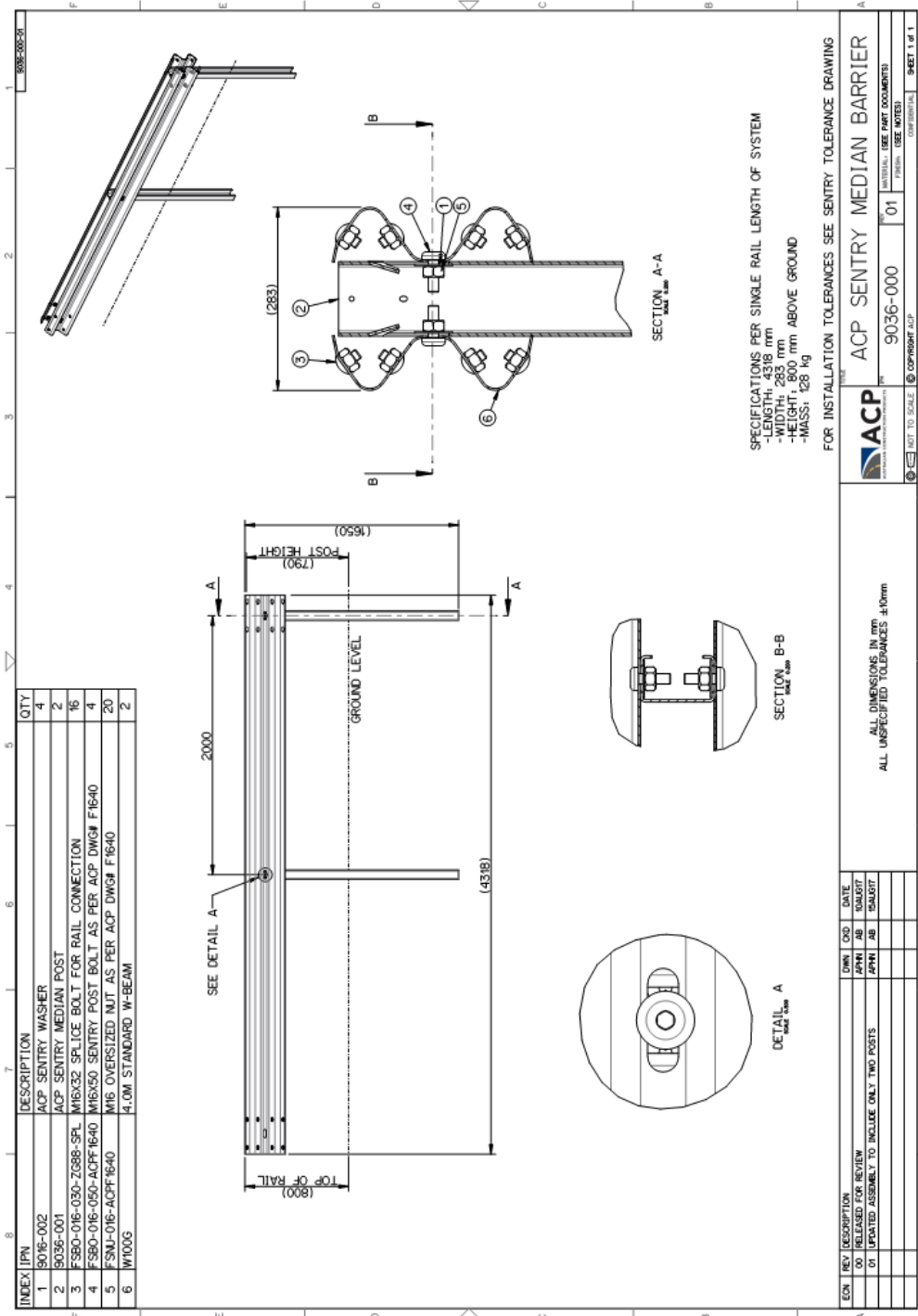

Product and Installation Manual: ACP Sentry Median Barrier

Appendix B – ACP SENTRY MEDIAN POST

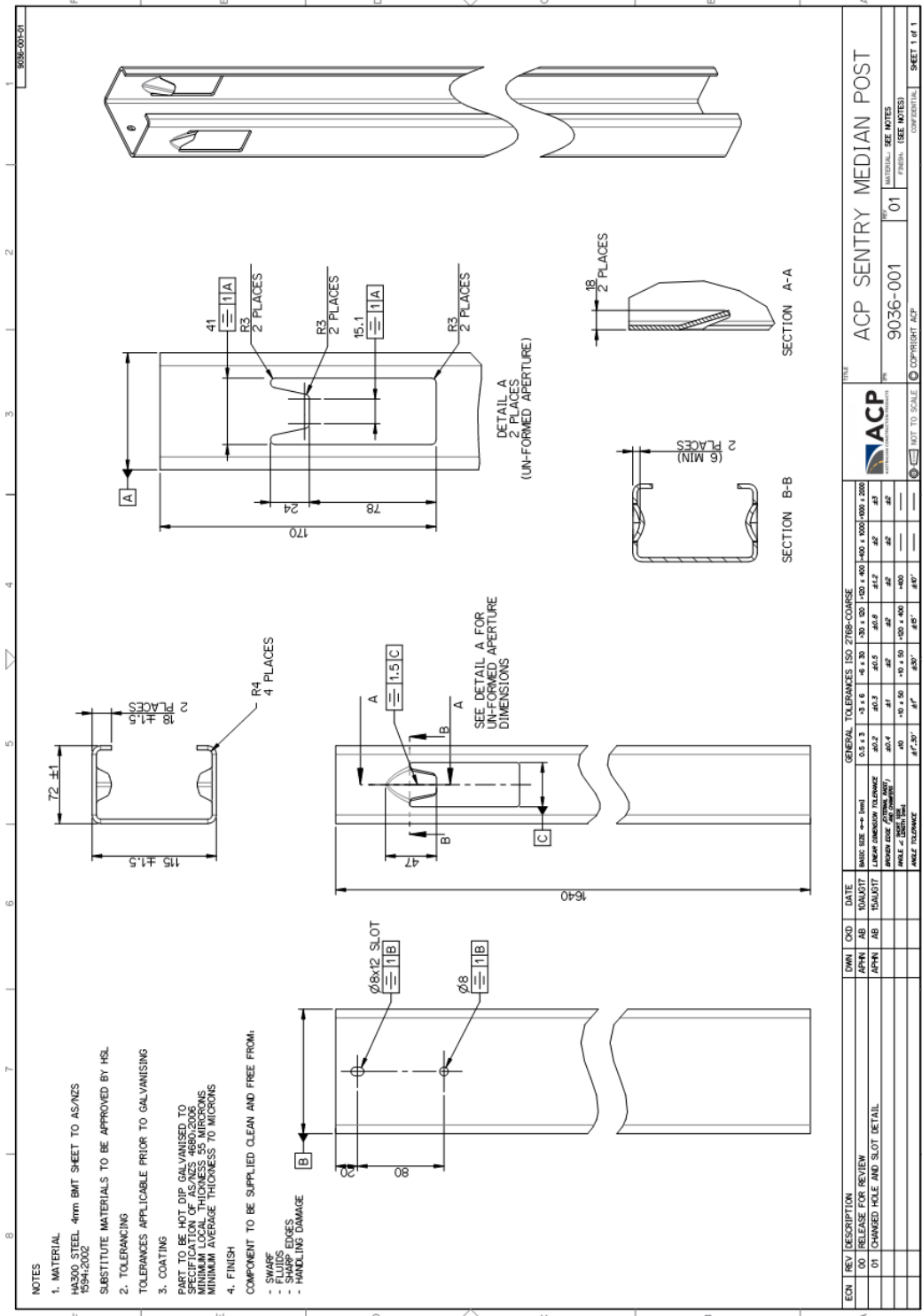

Product and Installation Manual: ACP Sentry Median Barrier

Appendix C – ACP SENTRY WASHER

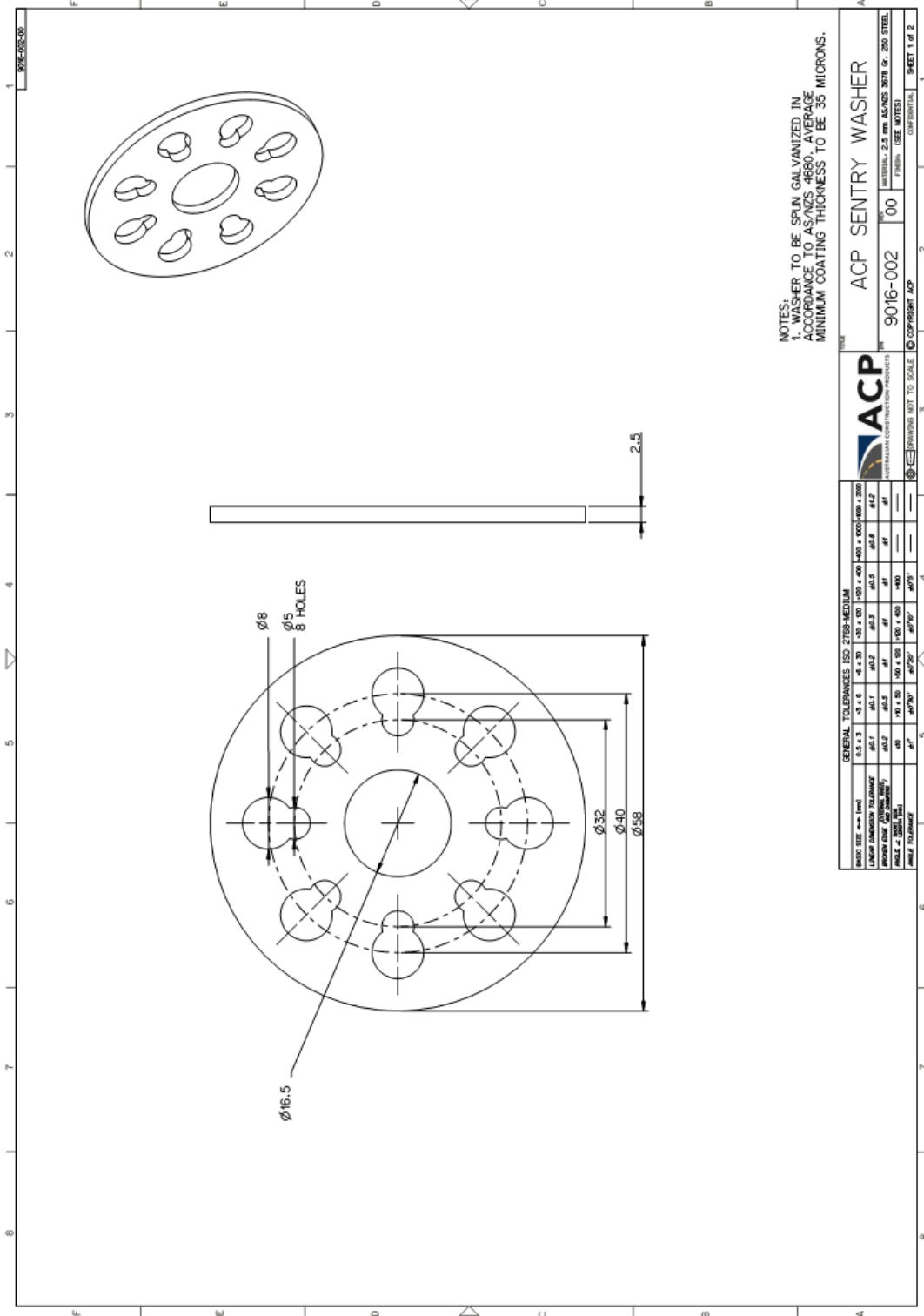

Product and Installation Manual: ACP Sentry Median Barrier

Appendix D – ACPF1640 (M16X50 Bolt and Nut)

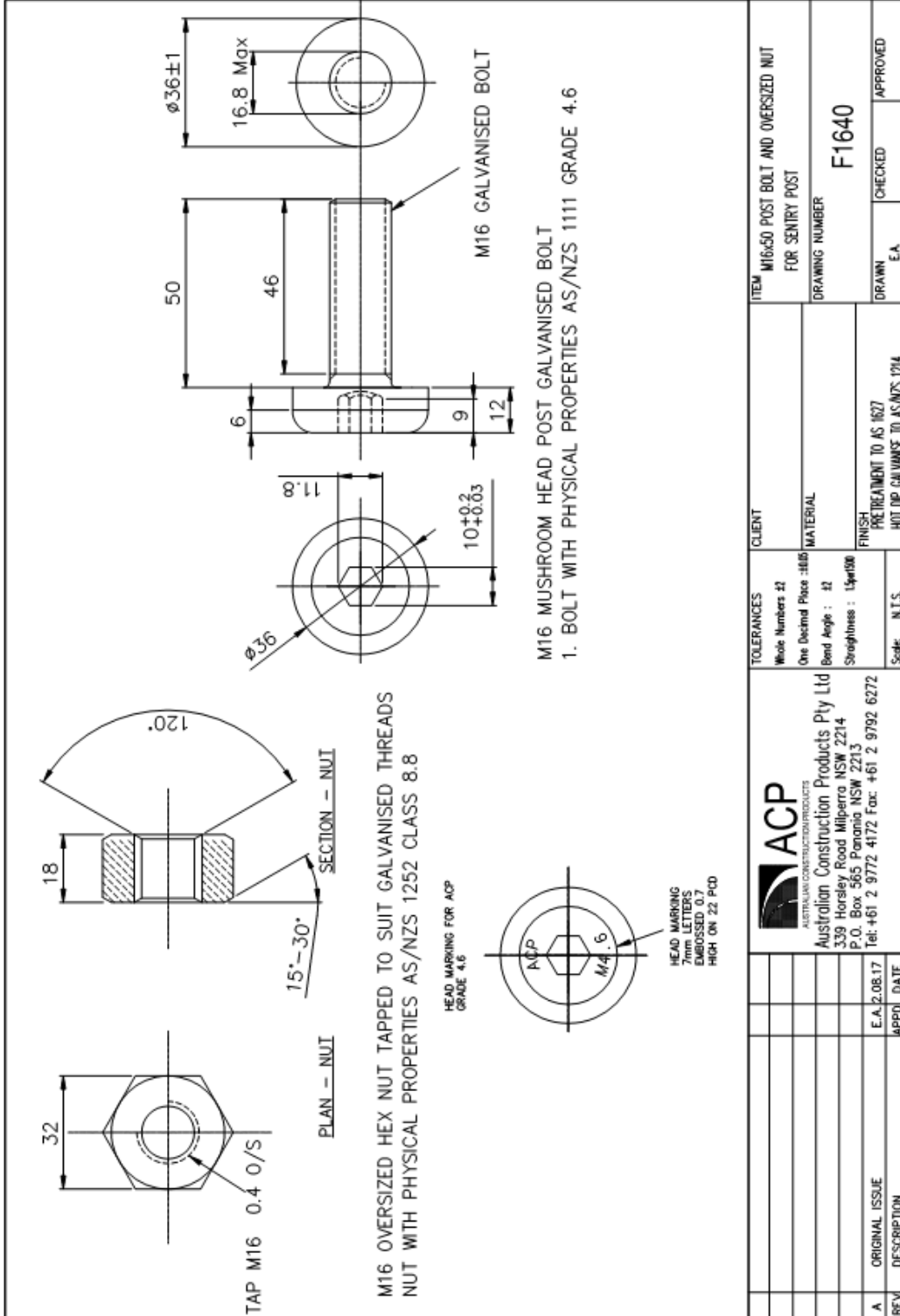

Product and Installation Manual: ACP Sentry Median Barrier

Appendix F – SENTRY MEDIAN BARRIER TRANSITION TO X350M MEDIAN TERMINAL

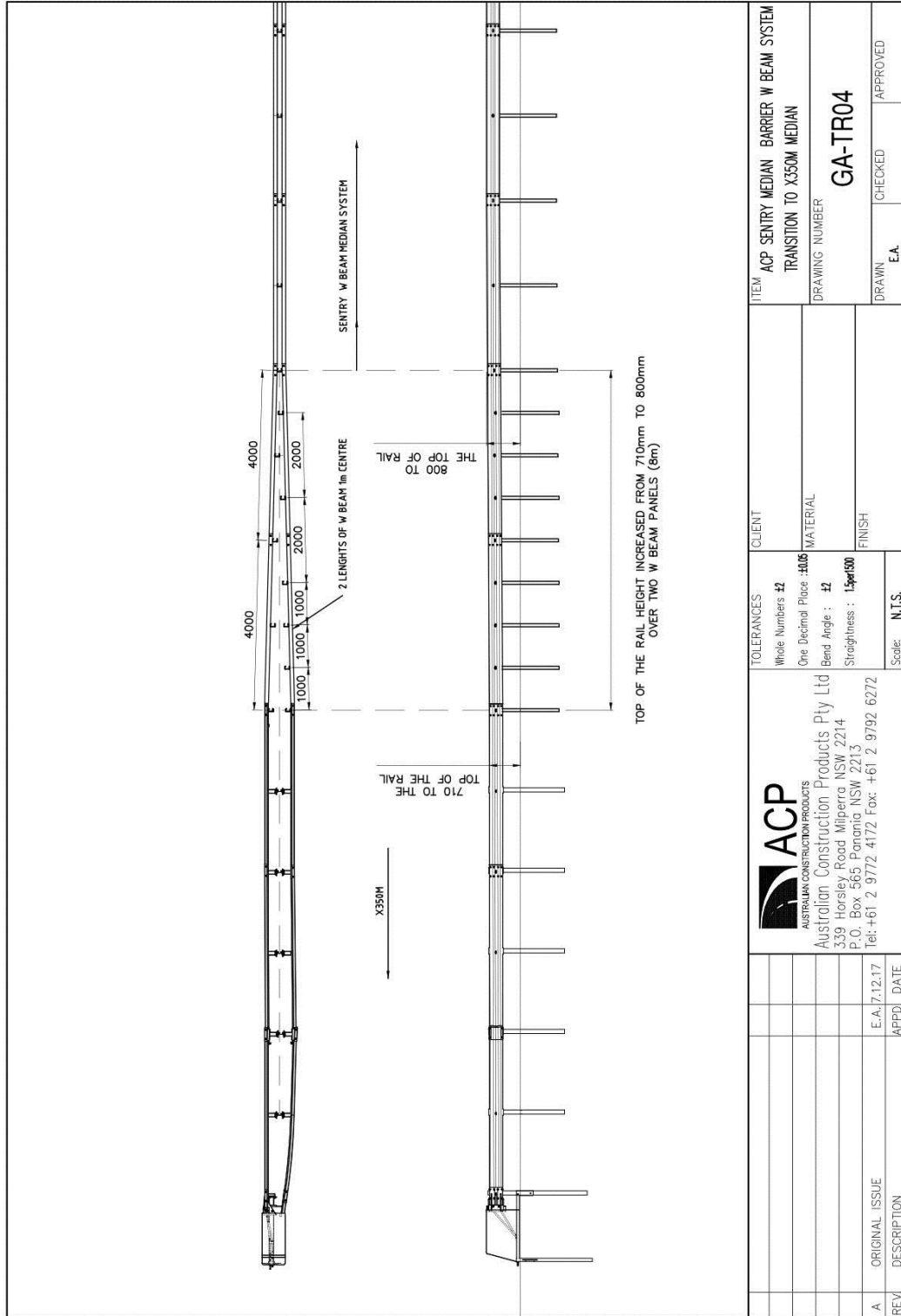

Product and Installation Manual: ACP Sentry Median Barrier

Appendix G – ACP SENTRY MEDIAN BARRIER INSTALLATION CHECKLIST

INSTALLATION CHECKLIST	Acceptable	Notifiable*
<p>General</p> <ul style="list-style-type: none"> ➤ Ensure the posts are orientated in the correct direction and consistent with the terminal ends. ➤ The height of the finished rail should be 800 mm (+25 mm) above the finished ground level. ➤ The height to the top of the posts should be 790 mm (+25 mm) above finished ground level. ➤ The posts are free from damage. ➤ The correct ACP Sentry Median Barrier Washes are installed and seated correctly in the back of the post. ➤ All bolts are tightened snug. ➤ The w-beam must be level and aligned to the terminal end. ➤ Ensure post are free of debris prior to installing the w-beam. 		
<p>Connected to a W-beam Terminal End</p> <ul style="list-style-type: none"> ➤ The top edge of the W-beam must align, both vertically and horizontally, between the ACP Sentry Median Barrier and the nominated terminal end. 		

*Any component or system identified as notifiable, must be highlighted to the local roading authority immediately. A notifiable item is defined as having the potential to interfere or hinder the ACP Sentry Median Barrier performance.

Comments:

Location:			
Installed by:		Date:	
Inspected by:		Date:	

Contact ACP for more information on this or other road safety products.







Product and Installation Manual: ACP Sentry Median Barrier

Appendix H – ACP SENTRY MEDIAN BARRIER INSPECTION CHECKLIST

To allow the **ACP Sentry Median Barrier** to perform as designed, regular inspections and maintenance (where required) should be conducted within a timely manner.



Local Roding Authorities may follow their own inspection process. Please contact your local Roding Authority, in the first instance, to confirm the correct processes or documentation required. This may include a specific response time for repairs, require spare parts to be carried by the inspector or the visual inspection by a qualified inspector.

Below are the tools that are required to inspect the **ACP Sentry Median Barrier**.

Tools Required	Supporting Image
➤ String line	
➤ Measuring tape	
➤ Level	
➤ 32 mm Socket wrench or ratchet	
➤ 32mm Ring spanner	
➤ Automatic drill (with 10 mm allen key hex bit)	

Product and Installation Manual: ACP Sentry Median Barrier

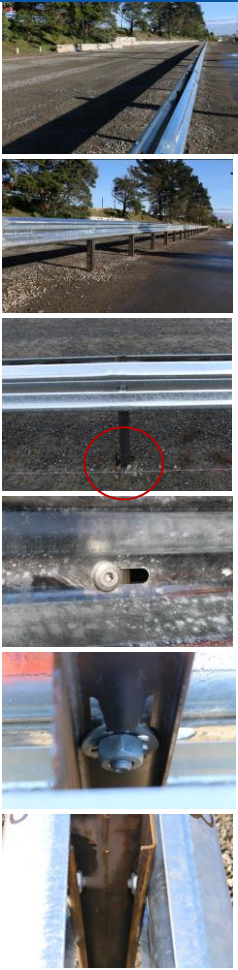
Below is the Inspection Checklist required when inspecting the **ACP Sentry Median Barrier**.
Once inspected, please forward a signed copy to the local roading authority.

Inspection Checklist	Supporting Image	Acceptable	Notifiable
<ul style="list-style-type: none"> ➤ Are there any signs of impact, scraping or snagging of the ACP Sentry Median Barrier? ➤ Are there any signs of fire damage to any of the ACP Sentry Median Barrier components? ➤ Are there any signs of damage of the ACP Sentry Median Barrier post, post footing and surrounding soil? ➤ Are all the ACP Bolts, Washers and Nuts fitted are tightened accordingly? <p><i>Caution: Over tightening of the nut can cause the washer to deform.</i></p>			
<ul style="list-style-type: none"> ➤ Are all posts, as stated in the Installation Manual, 790 mm (+25 mm) above ground level and no damage. ➤ Are all W-beam, as stated in the Installation Manual, 800 mm (+25 mm) above ground level. 			

Product and Installation Manual: ACP Sentry Median Barrier

- Is the barrier clear of debris or anything that may cause interaction of an errant vehicle?

- All components meet the Technical Specification stated in the Installation Manual. That is, no components have been switched out for alternate products.



*Any component or system identified as notifiable, must be highlighted to the local roading authority immediately. A notifiable item is defined as having the potential to interfere or hinder the **ACP Sentry Median Barrier** performance.

Comments:

Location:			
Inspected by:		Date:	
Approved by		Date:	

Contact ACP for more information on this or other road safety products.

Product and Installation Manual: ACP Sentry Median Barrier

Appendix I – ACCEPTABLE POST DEFORMATION MEASURES & TOLERANCES**Test 1: Nut Pass-through**

Ensure the nut can adequately pass through the slot at all locations along the slots length. This can be confirmed by physically checking fitment of the nut or alternatively measuring the width of the slot to ensure it is greater than that of the widest part of the bolt, typically 36.0 mm.

Any posts where the nut cannot pass through the slot should be rejected, and the deformation considered excessive.

**Test 2: Washer Fitment**

Ensure the washer can adequately fit into the required location to ensure the deformation is not excessive. This can be confirmed by physically placing the washer in the correct location and checking if it fits, even if tightly. For any post where the washer cannot be physically installed even if the fitment is tight, shall be rejected and the deformation considered excessive.



Product and Installation Manual: ACP Sentry Median Barrier

Test 3: Post deformation bending and cracking tolerance

If the bending deformation on any part of the post is less than 20 mm then the post shall be considered suitable for use. The deformation shall be measured by running a straight rule over the element to be measured and the peak off-set measured with a suitable rule or tape. See figure below to the left.

For cracking deformations, the maximum allowable deformation on the open side of the post will be limited to 15 mm. This limit is increased to 25 mm on the closed side of the post section due to the increased structural capacity of the web. See figure below to the right.

